

COMPACT LINE

Parallel-axis actuator family with optimized installation dimensions. Up to 3.500N.

Die Antriebsfamilie mit den optimalen Einbaumaßen durch parallel angeordnete Bauteile. Leistungen bis 3.500N.



AOP-1/M
AOP-1/Mi
AOP-1/Mt
AOP-2/M
AOP-2/Mi

AOP-1/M

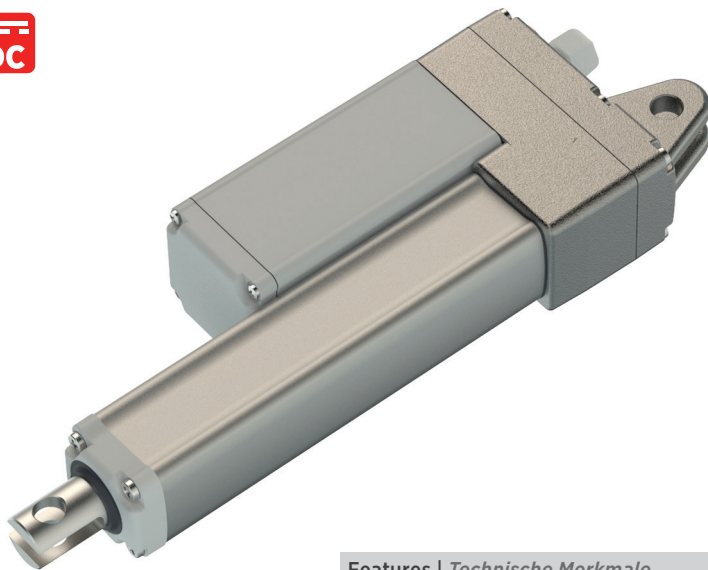

- Extra slim dimension
- Full metal body
- Multiple Gearing solutions
- Integrated end-stroke limit switches

Äußerst kompakte Abmessungen
 Metallgehäuse
 Umfangreiche Getriebevarianten verfügbar
 Integrierte Endschalter

Features | Technische Merkmale

DC Motors DC Motoren	12÷24÷36 V
Aluminium rod Alu Kolbenstange	
Standard protection Schutzart	IP44
Duty cycle Einschaltdauer	S3 10% based on 10 min. S3 10% basierend auf 10 min.
Operating temperature Betriebstemperatur	-20C° ÷ +60C°

Options | Optionen

Stainless steel rod Kolbenstange in Edelstahl
Anti rotation Verdrehgesicherte Kolbenstange
Increased protection up to IP69K Erhöhte Schutzart bis IP69K
Customizable stroke and retracted length Kundenspezifische Hübe und eingefahrene Längen
Various rear and front attachment available (0° and 90°) Befestigungsaugen in 0° und 90° Ausführung

Max thrust Push/Pull [N] Max Kraft Druck / Zug	Max speed [mm/s] Max Geschw.	Stroke length [mm] Hublänge	Installation dim. [mm] Einbaulänge (D)
1000	6	50÷300*	stroke/Hub + 115
750	12		
500	16		
300	20		
200	40		

*Longer stroke available upon request | Längere Hübe auf Anfrage möglich

Speed vs. Load | Geschwindigkeit / Kraft

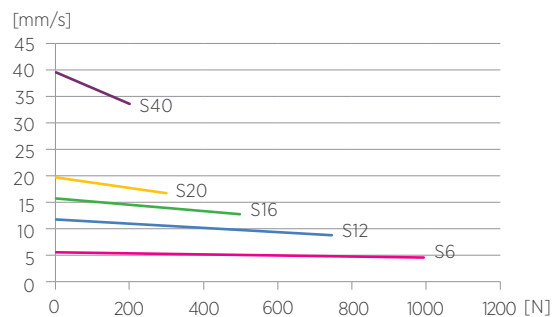

Current vs. Load | Stromaufnahme / Kraft

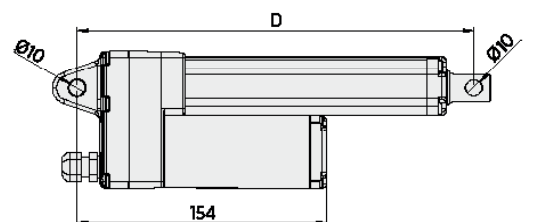
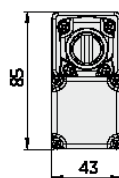
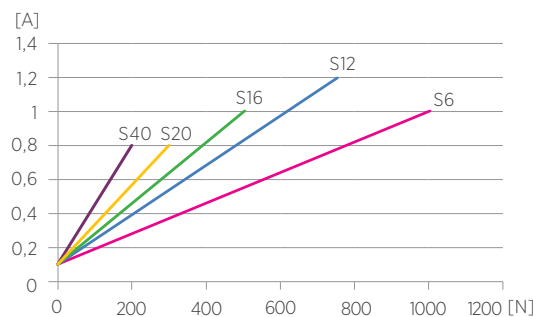

AOP-1/Mi

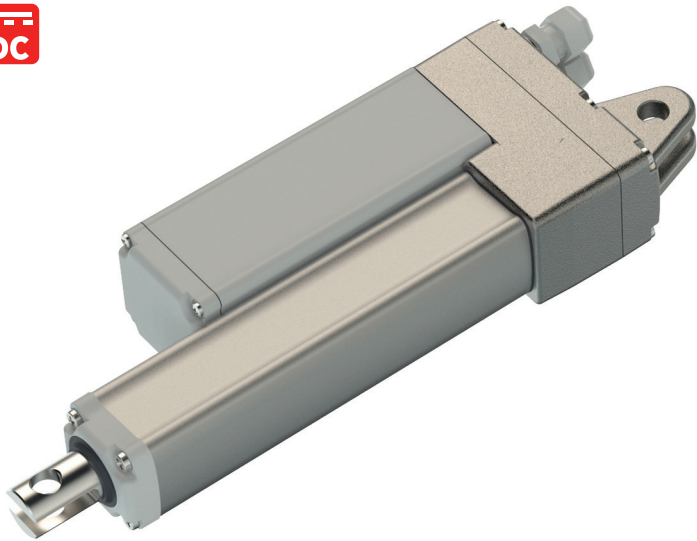

- Extra slim dimension
- Full metal body
- Multiple Gearing solutions
- Several integrated feedback solutions available

Äußerst kompakte Abmessungen
 Metallgehäuse
 Umfangreiche Getriebevarianten verfügbar
 Verschiedene Lagerrückmeldungen erhältlich

Features | Technische Merkmale

DC Motors DC Motoren	12÷24÷36 V
Aluminium rod Alu Kolbenstange	
Standard protection Schutzart	IP44
Duty cycle Einschaltdauer	S3 10% based on 10 min. S3 10% basierend auf 10 min.
Operating temperature Betriebstemperatur	-20C° ÷ +60C°
Digital-analog potentiometer or encoder Permanente verschleißfreie analoge oder digitale (Hall - Sensor) Lagerückmeldung	

Options | Optionen

Stainless steel rod Kolbenstange in Edelstahl
Anti rotation Verdrehgesicherte Kolbenstange
Increased protection up to IP69K Erhöhte Schutzart bis IP69K
Customizable stroke and retracted length Kundenspezifische Hübe und eingefahrene Längen
Various rear and front attachment available (0° and 90°) Befestigungsaugen in 0° und 90° Ausführung

Max thrust Push/Pull [N] Max Kraft Druck / Zug	Max speed [mm/s] Max Geschw.	Stroke length [mm] Hublänge	Installation dim. [mm] Einbaulänge (D)
1000	6	50÷300*	stroke/Hub + 115
750	12		
500	16		
300	20		
200	40		

*Longer stroke available upon request | Längere Hübe auf Anfrage möglich

Speed vs. Load | Geschwindigkeit / Kraft

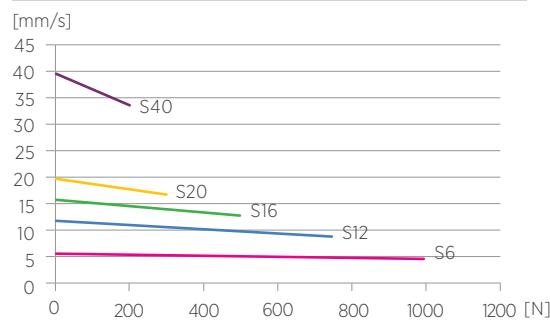

Current vs. Load | Stromaufnahme / Kraft

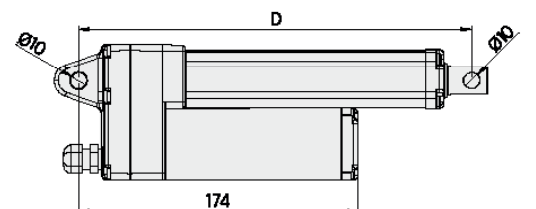
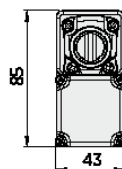
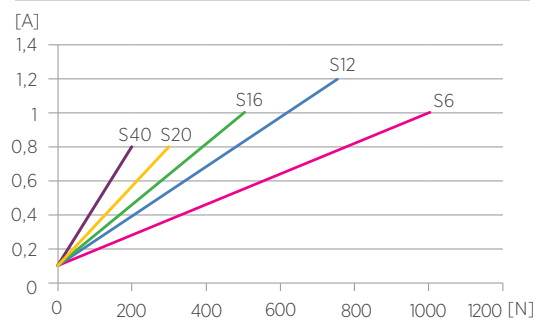

AOP-1/Mt

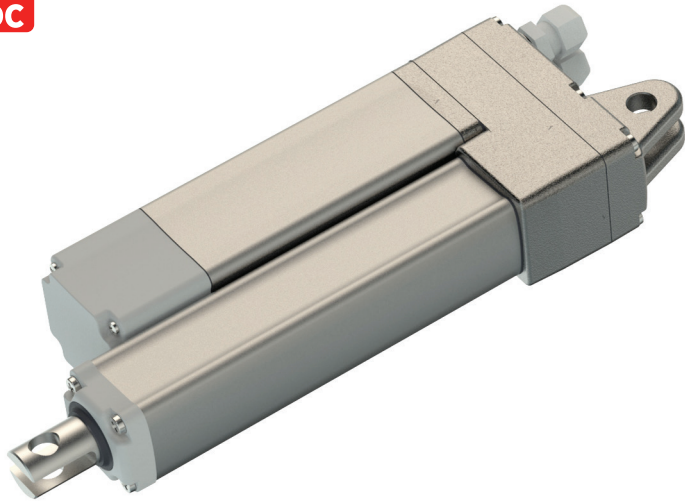

Extra slim dimension
 Full metal body
 Multiple Gearing solutions
 Plenty place for customized electronics built in

Sehr kompakte Abmessungen
Metallgehäuse
Umfangreiche Getriebevarianten verfügbar
Integrationsmöglichkeiten für kundenspezifische Elektronik

Features | Technische Merkmale

DC Motors DC Motoren	12÷24÷36 V
Aluminium rod Alu Kolbenstange	
Standard protection Schutzart	IP44
Duty cycle Einschaltdauer	S3 10% based on 10 min. S3 10% basierend auf 10 min.
Operating temperature Betriebstemperatur	-20C° ÷ +60C°
Customizable aluminium motor housing Kundenspezifische Aluminium - Gehäuselängen	

Options | Optionen

Stainless steel rod Kolbenstange in Edelstahl
Anti rotation Verdrehgesicherte Kolbenstange
Increased protection up to IP69K Erhöhte Schutzart bis IP69K
Customizable stroke and retracted length Kundenspezifische Hübe und eingefahrene Längen
Various rear and front attachment available (0° and 90°) Befestigungsaugen in 0° und 90° Ausführung

Max thrust Push/Pull [N] Max Kraft Druck / Zug	Max speed [mm/s] Max Geschw.	Stroke length [mm] Hublänge	Installation dim. [mm] Einbaulänge (D)
1000	6	50÷300*	stroke/Hub + 115
750	12		
500	16		
300	20		
200	40		

*Longer stroke available upon request | Längere Hübe auf Anfrage möglich

Speed vs. Load | Geschwindigkeit / Kraft

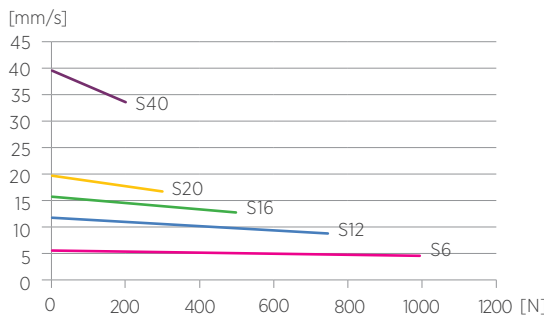

Current vs. Load | Stromaufnahme / Kraft

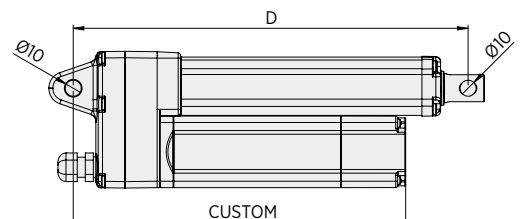
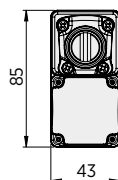
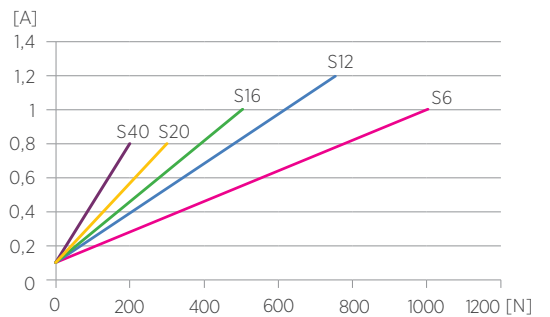

AOP-2/M



Compact dimensions
 Designed for heavy and harsh applications
 Powerful and fast
 Integrated end-stroke limit switches

*Kompakte Ausführung
 Entwickelt für raue und anspruchsvolle Umgebungen
 Leistungsstark und schnell
 Integrierte Endschalter*

Features | Technische Merkmale

DC Motors DC Motoren	12÷24÷36 V
Stainless steel rod Kolbenstange in Edelstahl	
Standard protection Schutzart	IP44
Duty cycle Einschaltdauer	S3 10% based on 10 min. S3 10% basierend auf 10 min.
Operating temperature Betriebstemperatur	-20C° ÷ +60C°

Options | Optionen

Anti rotation Verdrehgesicherte Kolbenstange
Increased protection up to IP69K Erhöhte Schutzart bis IP69K
Customizable stroke and retracted length Kundenspezifische Hübe und eingefahrene Längen
Various rear and front attachment available (0° and 90°) Befestigungsäugen in 0° und 90° Ausführung

Max thrust Push/Pull [N] Max Kraft Druck / Zug	Max speed [mm/s] Max Geschw.	Stroke length [mm] Hublänge	Installation dim. [mm] Einbaulänge (D)
3500	3	50÷300*	stroke/Hub + 123
2500	7		
1500	10		
1000	18		
800	26		
400	35		

*Longer stroke available upon request | Längere Hübe auf Anfrage möglich

Speed vs. Load | Geschwindigkeit / Kraft

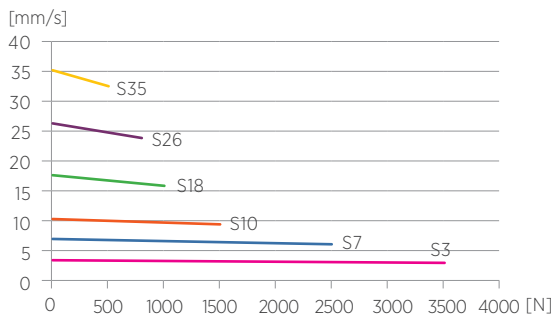

Current vs. Load | Stromaufnahme / Kraft

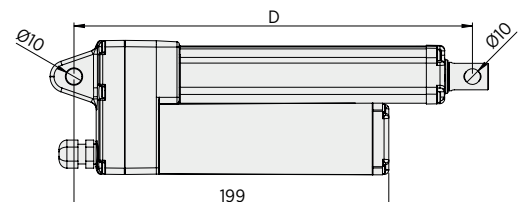
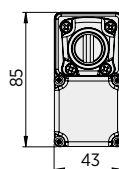
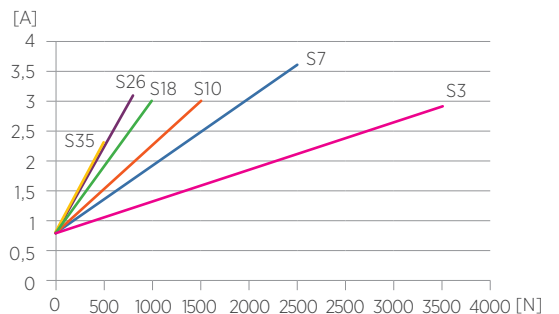

AOP-2/Mi

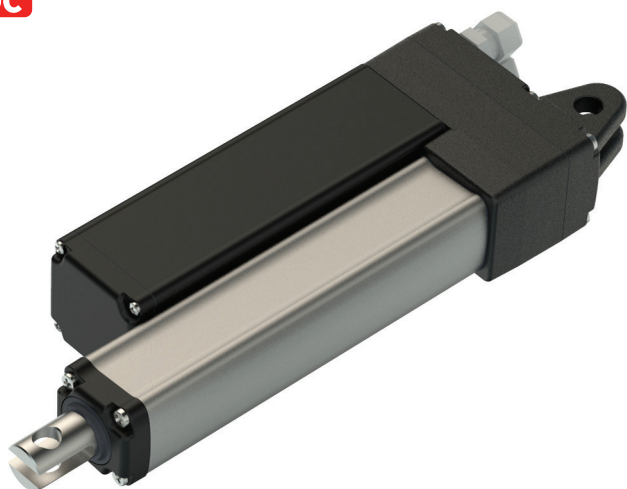

Compact dimensions
 Designed for heavy and harsh applications
 Powerful and fast
 Several integrated feedback solutions available

Kompakte Ausführung
Entwickelt für raue und anspruchsvolle Umgebungen
Leistungsstark und schnell
Verschiedene Lagerückmeldungen erhältlich

Features | Technische Merkmale

DC Motors DC Motoren	12÷24÷36 V
Stainless steel rod Kolbenstange in Edelstahl	
Standard protection Schutzart	IP44
Duty cycle Einschaltdauer	S3 10% based on 10 min. S3 10% basierend auf 10 min.
Operating temperature Betriebstemperatur	-20C° ÷ +60C°
Digital-analog potentiometer or encoder Permanente verschleißfreie analoge oder digitale (Hall - Sensor) Lagerückmeldung	

Options | Optionen

Anti rotation Verdrehgesicherte Kolbenstange
Increased protection up to IP69K Erhöhte Schutzart bis IP69K
Customizable stroke and retracted length Kundenspezifische Hübe und eingefahrene Längen
Various rear and front attachment available (0° and 90°) Befestigungsaugen in 0° und 90° Ausführung

Max thrust Push/Pull [N] Max Kraft Druck / Zug	Max speed [mm/s] Max Geschw.	Stroke length [mm] Hublänge	Installation dim. [mm] Einbaulänge (D)
3500	3	50÷300*	stroke/Hub + 123
2500	7		
1500	10		
1000	18		
800	26		
400	35		

*Longer stroke available upon request | Längere Hübe auf Anfrage möglich

Speed vs. Load | Geschwindigkeit / Kraft

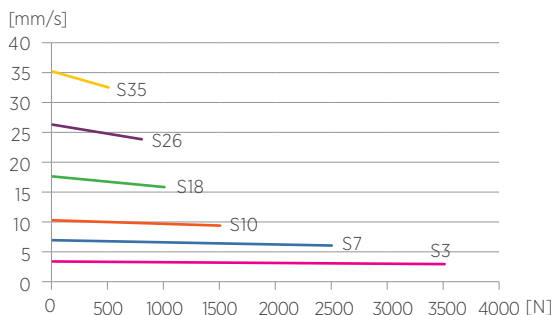

Current vs. Load | Stromaufnahme / Kraft

